



Paper Cushion Machine User Manual

LP-C1



Hangzhou Bing Jia Tech. Co.,Ltd

Tel:+86 571 86169196 Email:info@lockedair.com

7F,11th Building,West Area,Chinese Artificial Intelligence Town(CAIT),

Hangzhou 31121,Zhejiang,P.R.China

1. User instructions

Thank you for using the LockedPaper paper cushion machine. This manual is written in an easy-to-understand manner, allowing the operator to quickly and easily become familiar with the location of the machine components, the operation of the machine, and the basic principles of troubleshooting and fault correction.

Tips: The operation of different types of machines is slightly different, please pay attention to the tips in the main text of the manual. Only those who have read and understood the chapters such as "Safety", "Product Introduction" and "Product Operation" can operate this machine;

Only service technicians employed by LockedPaper or its distributors are allowed to maintain this machine;

Operator responsibilities include:

- Operate machinery
- Carry out regular maintenance (see Section 9)

NOTE: Only service technicians employed by LockedPaper or a LockedPaper dealer are allowed to service this machine.

2. Safety

2.1. Safety instructions manual

The power supply used by the machine must be consistent with the parameters on the machine nameplate.

Misconnection is strictly forbidden. To prevent damage to the machine, please only use the power cord provided with the product.

- Ensure the power supply is earthed.
- Do not disable or remove safety devices.
- Do not remove or cover Warning markings.
- Keep work area clean and accessible.
- Unplug the power cord and collect any loose wires together before moving the machine.
- Beware of hurting hands when using knives or scissors.

Make sure:

- No damage to cables
- Work areas should be well lit
- Work area is well ventilated

Safety specification design: The mechanical structure design complies with CE safety specification requirements. All dangerous parts cannot be touched by hand.

2.2. Machine warning

Do not touch any moving parts when operating the machine.

Do not open the maintenance cover without training.

Do not remove the safety switch latch from the cover.

The machine will alarm if there are any errors.



Keep Hands Away: Keep hands away from

the cutters to prevent avoid during maintenance.



Beware of Mechanical Injury: Do not put hands

in channels to avoid injury during maintenance.



Lightning Tip: Indicates that some machine parts

inside the equipment are not electrically insulated. Caution! Risk of electric shock!

Press the emergency stop and unplug the power supply if you encounter any of the following situations:

- Foreign matter at the input channel

- Abnormal sounds are produced inside the machine
- Other abnormal situations

2.3. Improper use

The following applications or operations are inappropriate for the machine and are considered improper use:

- Reference to other documents not provided by LockedPaper
- Used outdoors or in wet environments
- Used in areas where explosion accidents may occur
- Using excess water to wash or clean the machine
- Stand on the machine
- Place objects on or on top of the machine
- Move the machine while it is running or still connected to AC power

2.4. Storage

- Never place or store the machine in a damp or watery environments
- Before using the machine again after long-term storage, it must be inspected by a trained service technician
- The machine should be stored in an environment with a temperature range of $-25\sim+55^{\circ}\text{C}$ ($-13\sim131^{\circ}\text{F}$) and a relative humidity range of 10%~90%RH.



If the machine is brought from a colder area to a warmer area, condensation may form on the machine (inside and outside), which may damage the machine and injure the operator if the power is turned on immediately. Allow the machine return to room temperature and wait for the condensation to evaporate before turning on the power.

2.5. Transportation

- The machine should not experience severe vibration or impact during transportation.
- The machine must not be exposed to the sun or rain, and should be stored within the required temperature and humidity range.

3. Disclaimer

The manufacturer and its authorized distributors are not responsible for any accident or damage caused by violation of the warnings or instructions contained in the description of this machine or this manual.

- Improper use or maintenance
- Use in applications or under conditions other than those specified in this manual.
- Use of unauthorized parts
- Use material not produced by LockedPaper
- Repairs or modifications without the manufacturer's permission
- Unauthorized modifications to the machine, such as:







- Change the control system
- Welding, mechanical processing, etc.
- Extend the machine or control system

The manufacturer and its authorized distributors are not responsible for:

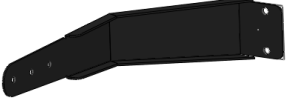
- Consequential damage caused by machine errors or malfunction (such as product damage, business interruption, delays, etc.).

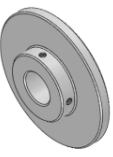
4. Machine Installation Guide

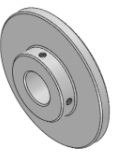
4.1. Assemble the Stand.

<p>Base gasket (including tray and casters) × 1</p> 	<p>Paper guide shaft support × 2</p> 	<p>Column × 1</p> 
<p>Paper Guide Shaft Rib × 4</p> 	<p>Paper guide shaft × 3</p> 	<p>1.5mm Allen wrench × 1 4mm Allen wrench × 1 6mm Allen wrench × 1</p>
		

① **Installing Column** : "M8*20 combination screws are used, assembled and fixed with an 6mm Allen wrench.

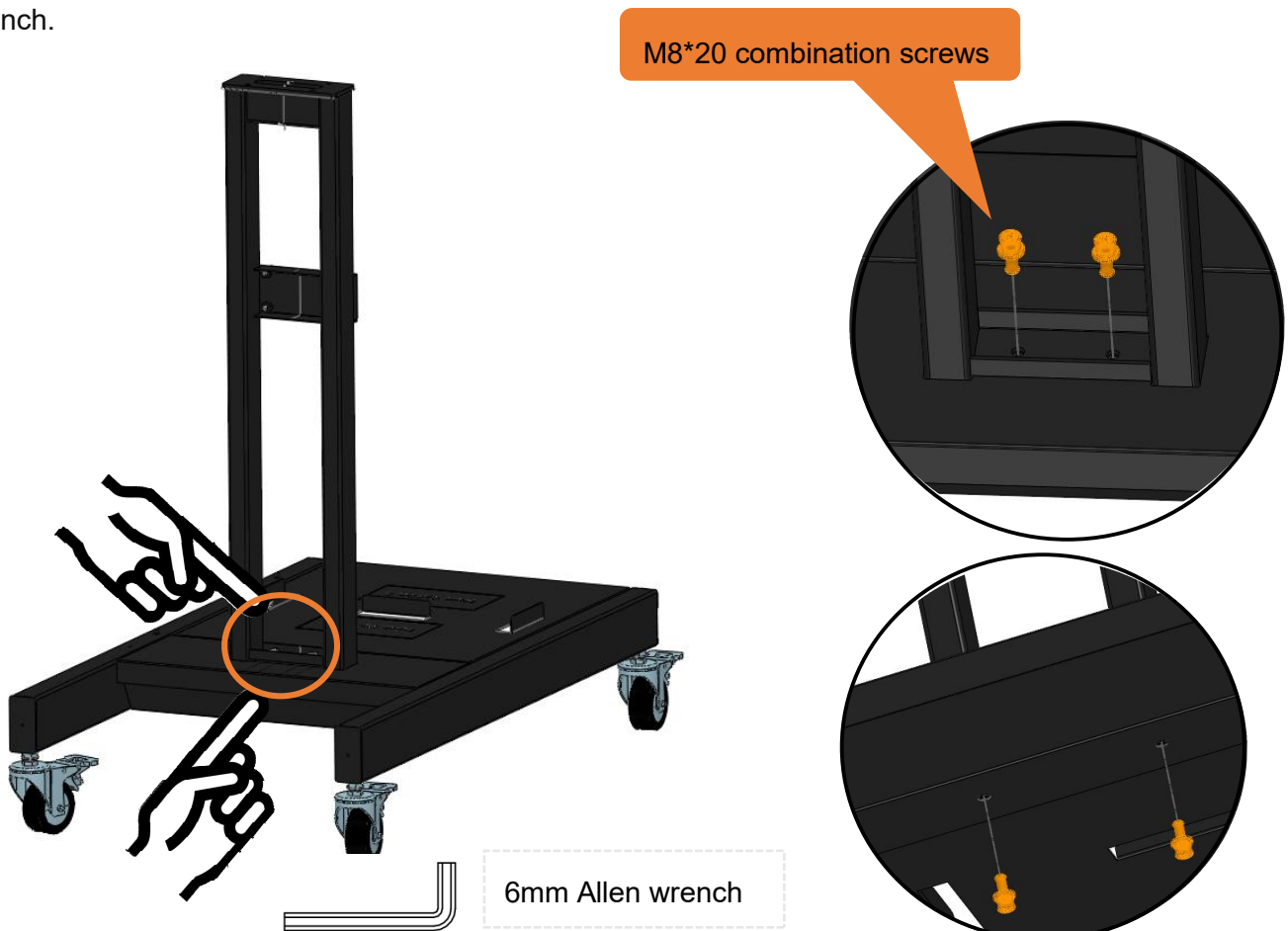

② **Installing Paper guide shaft support:** "M8*20 combination screws are used, assembled and fixed with an 6mm Allen wrench.

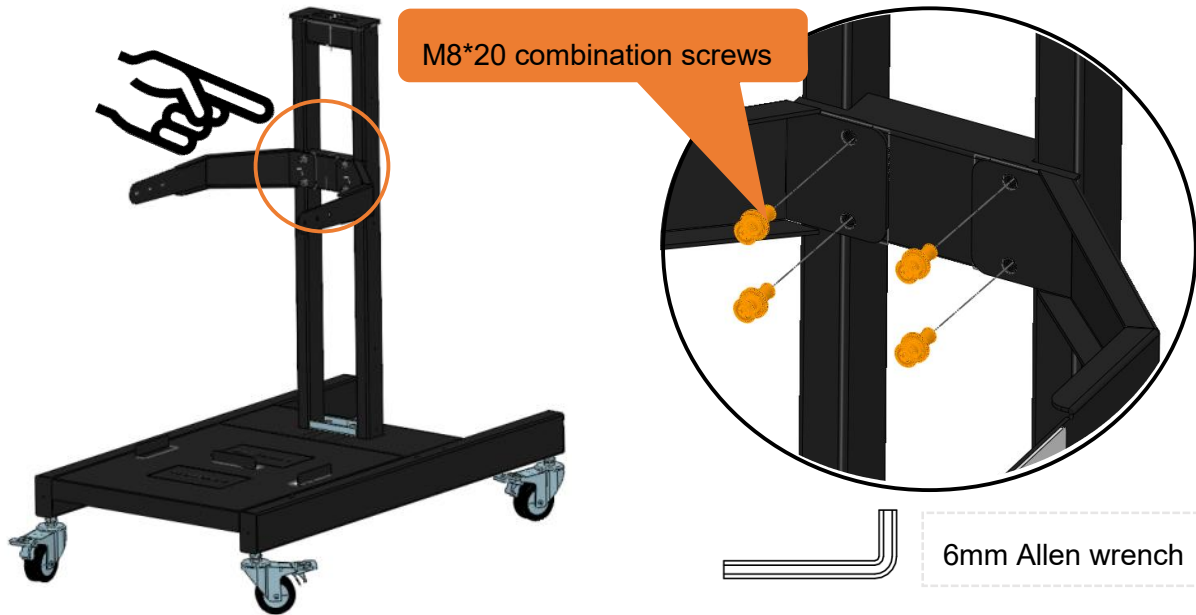

③ **Paper Guide Shaft Installation:** Install the Paper Guide Shaft and the Paper Guide Shaft Rib into the Paper Guide Shaft Bracket using M6x12 combination screws, and tighten the screws with a 1.5mm Allen key.

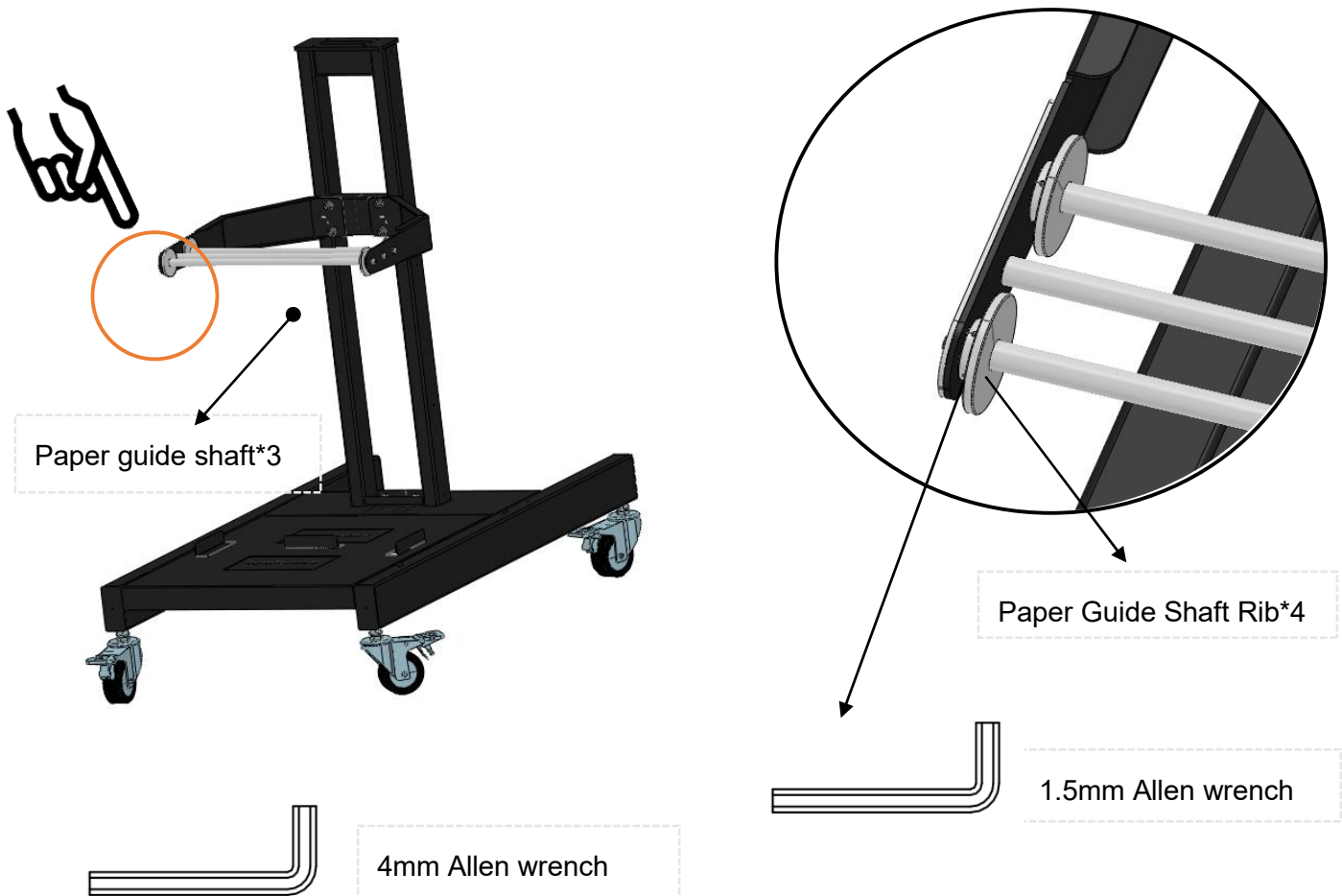

4.2. Assemble the Machine

Machine body × 1	Tail stock × 1	Pedal × 1
		

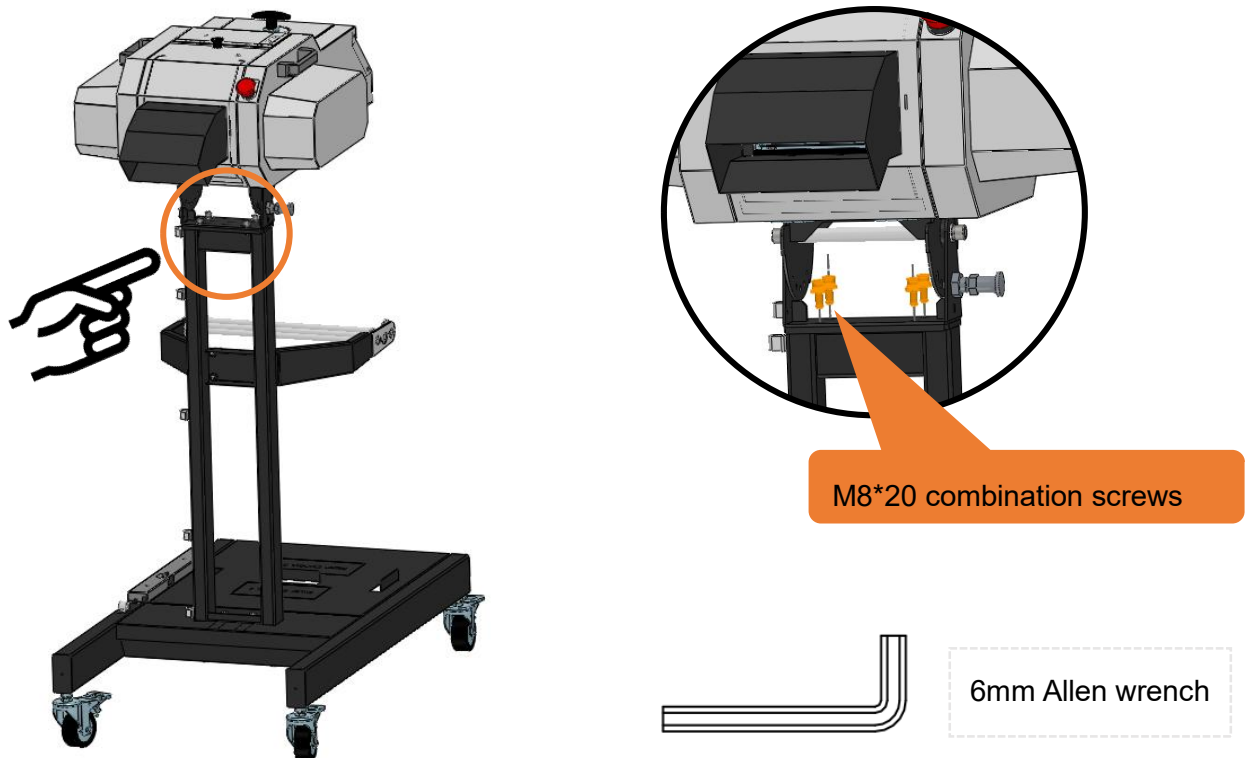

① M8*20 combination screws are used, assembled and fixed with an 6mm Allen wrench.

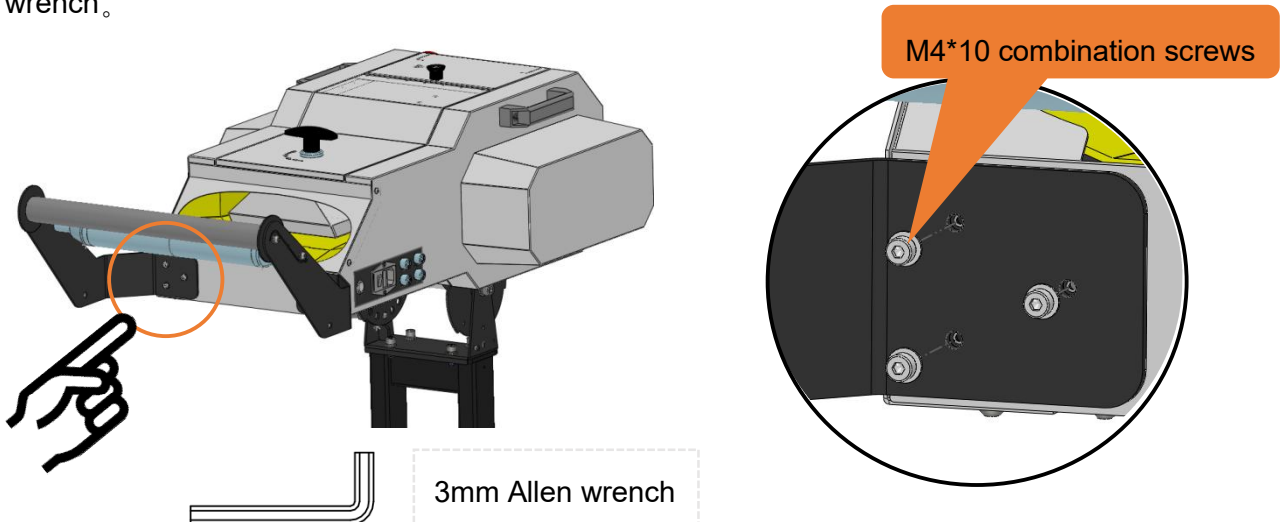

② **Installing Tail stock:** M4*10 combination screws are used, assembled and fixed with an 3mm Allen wrench.

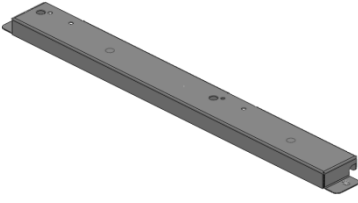
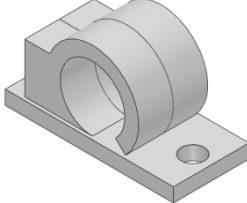

4.3. paper empty sensor (optional part)

paper empty sensor ×1	Cable Buckle×6	3mm Allen wrench×1
		

① **Installing Cable Buckle :** M4*8 combination screws are used, assembled and fixed with an 3mm Allen wrench

② **Installing Detection components:** M4*8 combination screws are used, assembled and fixed with an 3mm Allen wrench

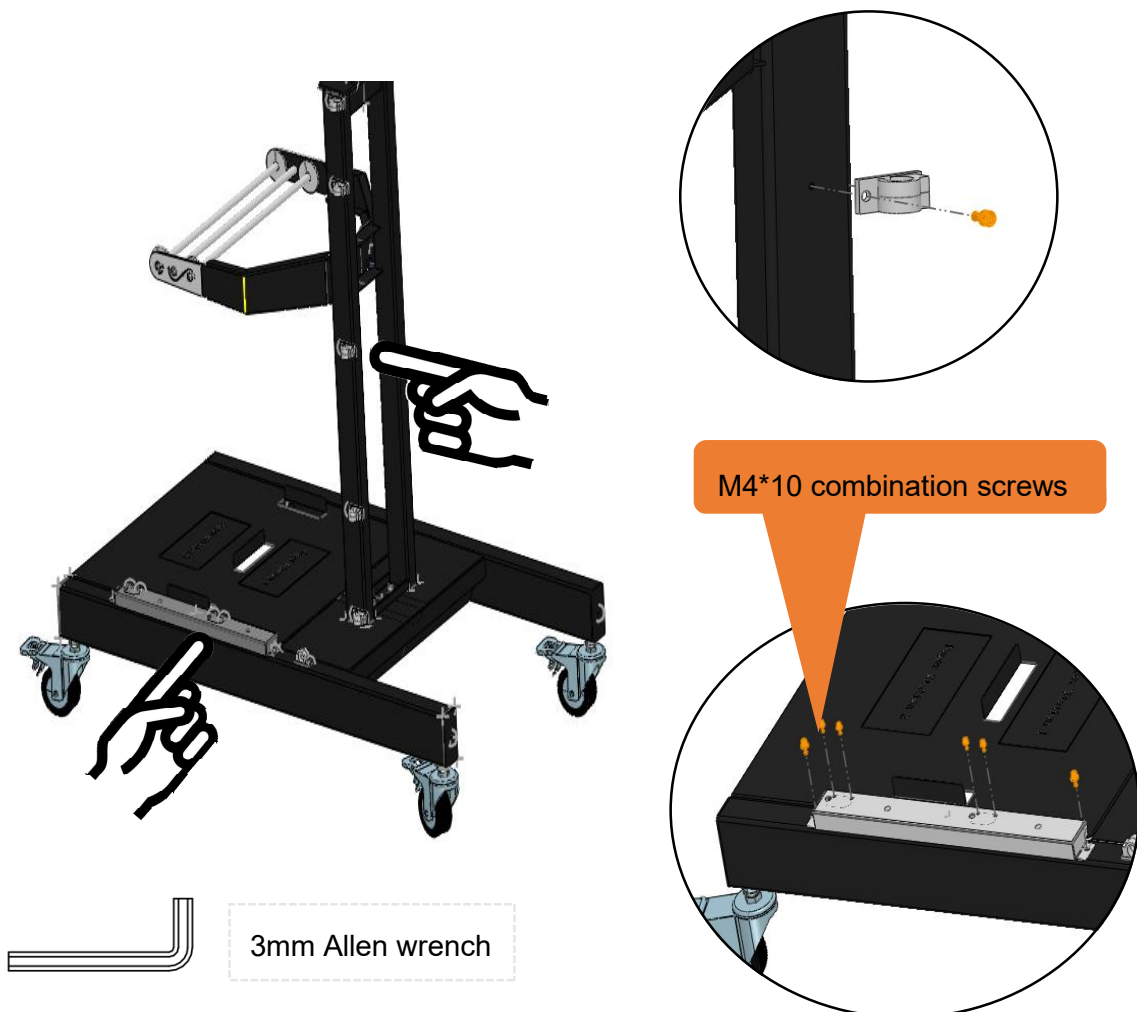

5. Introduction

5.1. Product Introduction

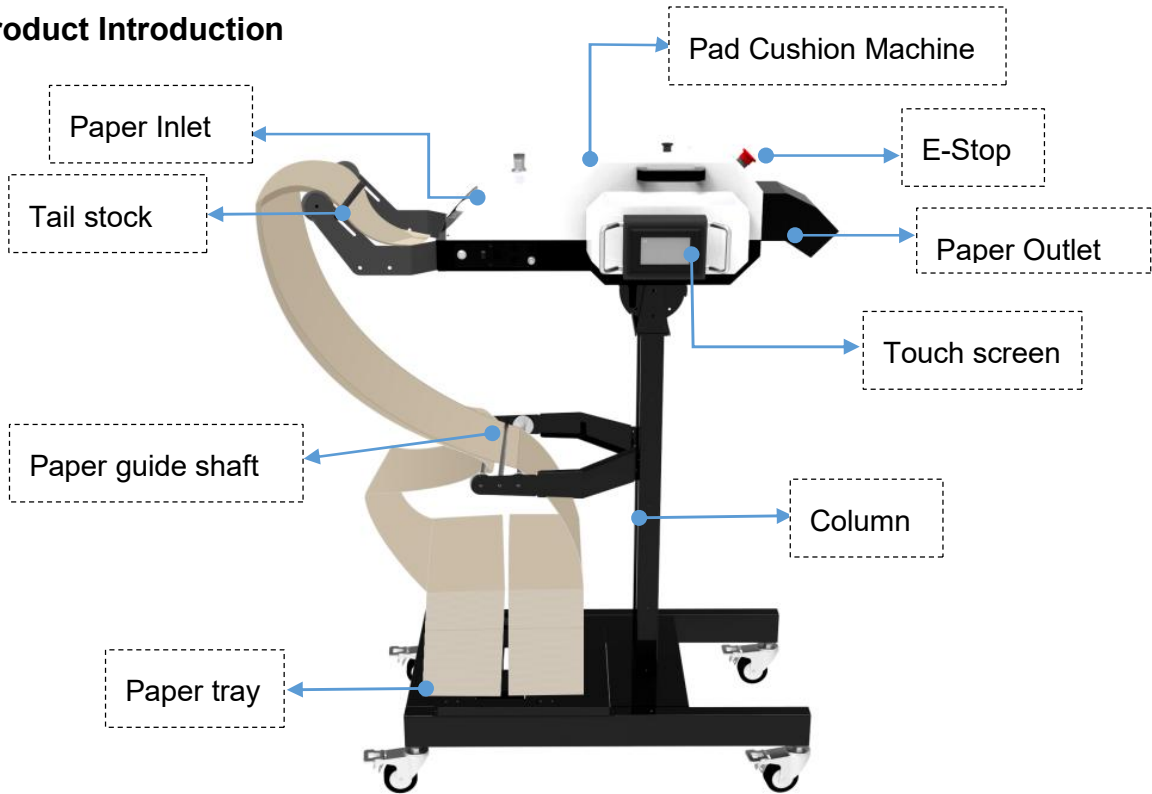

5.2. Circular connectors

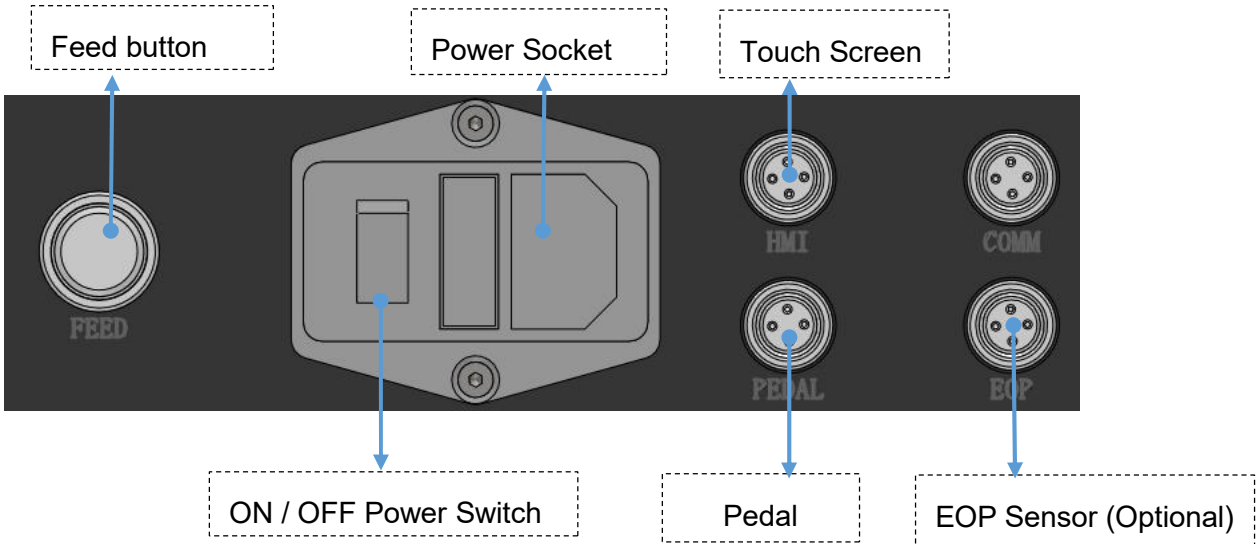

6. Operation

6.1. Plugging in the Power

Step1: Connect the touch screen, pedal and paper empty sensor (optional part, please contact with distributors if you need to order this part) to the machine.

Step2: Close all of covers and remove your hands from the machine outlet before plugging in the power.

Step3: Check the status of the emergency stop, turn it off before start the machine.

- a. If the emergency stop is on, please turn the knob clockwise before starting the machine.
- b. If the emergency stop is off, please start the machine directly.

6.2. Feeding

- 1) Place two bundles of paper on the corresponding positions of Paper Tray 1 and Paper Tray 2 ,cut off and pull out the strapping tape on each bundle;
- 2) Wind the two bundles of paper onto the feeding rod of the tray as shown in Figure ①;
- 3) After two bundles of paper converge and emerge into double-layer,as shown in Figure ②,then go around into the feed inlet;
- 4) Fold the two corners on the top of the paper into a triangle as shown in Figure ③;
- 5) Push the folded paper forward,then press “ FEED” button,the machine will automatically pull the paper inside;
- 6) Keep pressing” FEED” button until you find paper at the outlet,then release the “Feeding” button. When the paper feeding is finished successfully,the machine can be used normally.

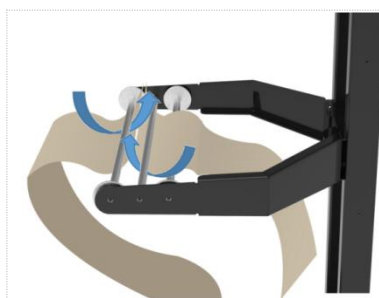
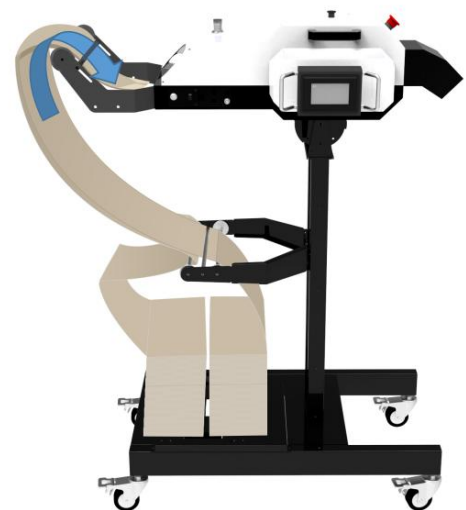

Figure①

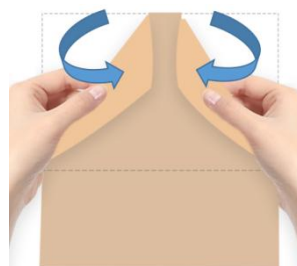

Figure②

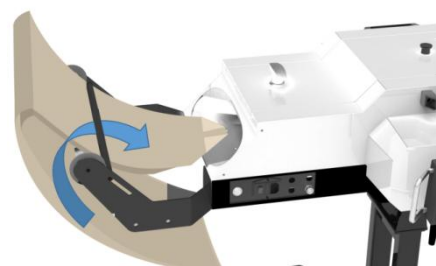

Figure③

7. Screen

7.1. Homepage

Tap the icon to enter different modes as needed.

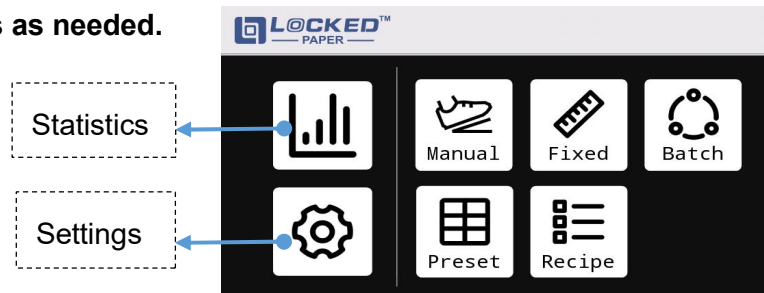

7.2. Description of the Icon

: Machine Starts	: Return to Previous Page
: Machine Ends	: Return to Homepage

7.3. Description of the Parameters

Length Range: 25~3600cm / 9.8~1417 inch	: Output Speed
Pads Number: 0~99999 Pcs	(3 speed levels, we recommend the high level)

7.4. Manual Mode

This mode enables users to control the length of the paper output by triggering the switch duration and stopping it when it is released.

1) Tap in the homepage to enter this mode. (Figure 1).

2) Operation:

- a. Start Mode: Press pedal or tap to start.
- b. Length Control: Press and hold to extend, release to stop.
- c. Instant Cut off: The paper is automatically cut off when the machine stops.
- d. Limited Length: The machine will produce a minimum length when releasing quickly after triggering.
- e. Statistics Record: The length is displayed immediately in the gray area next to "Produced Length".

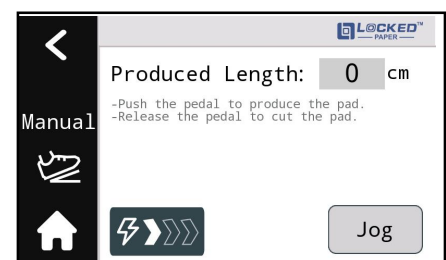



Figure 1

7.5. Fixed Mode

This mode enables users to produce paper of a preset length.

1) Tap  in the homepage to enter this mode. (Figure 2).

2) Operation:

a. Preset Length: Tap the number to set pad length.

b. Start Mode: Press pedal or tap  to start.

c. Output Mode: Tap  to switch output mode:

: Produce only one pad when starting machine.

It's suitable for small batches or immediate requirements.

: Produce in with efficiency, the machine will consistently produce the preset length of paper

when triggered. The machine automatically produces paper after taking the previous pad,

until the machine is stopped manually or the paper runs out.

It's suitable for continuous batch requirements.

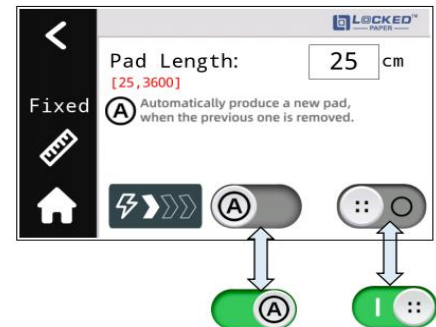



Figure 2

7.6. Batch Mode

This mode enables users to produce paper of a preset length, with the machine automatically stopping when the preset number has been reached.

1) Tap  in the homepage to enter this mode. (Figure 3).

2) Operation:

Preset Parameters:

Tap the number of "Pad Length" to set pad length.

Tap the number of "Amount" to set pad amount.

Start Mode: Press pedal or tap  to start.

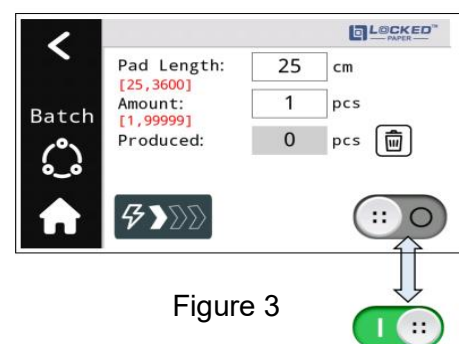

Figure 3

3) Automatic Production: the machine automatically produces paper of a preset length, until the preset number is reached.

4) Statistics Record: The produced number is displayed immediately in the gray area next to

"Produced". It is automatically reset when the process is finished. It can also be reset by tapping 



when the machine is stopped.

7.7. Preset Mode

This mode enables users to select one of the 8 preset paper lengths, which the machine will then produce.

1) Tap  in the homepage to enter this mode. (Figure 4a).

2) Operation:

Preset Length: Tap  to enter the editing page, tap  to return to the previous page after editing the paper length. (Figure 4b).

Start Mode: Press pedal to start.

3) Length Select: Tap the number to switch paper length, the machine will then produce the appropriate output. It can also produce paper by taping the next number instead of taking the previous pad.

4) Output Mode: Tap  to switch output mode:

: Produce only one pad when starting machine.

It's suitable for small batches or immediate requirements.

: Produce in with efficiency, the machine will consistently produce the preset length of paper when triggered. The machine automatically produces paper after taking the previous pad, until the machine is stopped manually or the paper runs out.

It's suitable for continuous batch requirements.

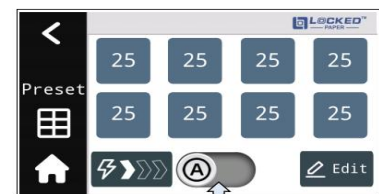

Figure 4a

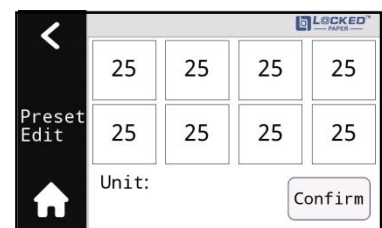



Figure 4b

7.8. Recipe Mode

This mode enables users to produce paper with a customer recipe, which includes a series of paper lengths and pads numbers.

1) Tap  in the homepage to enter this mode. (Figure 5).

2) Operation:

Preset Recipe: Set the paper length (from 50 to 360 cm) and pads number.

The machine will skip "0" when working.

3) Start Mode: Press pedal or tap  to start.

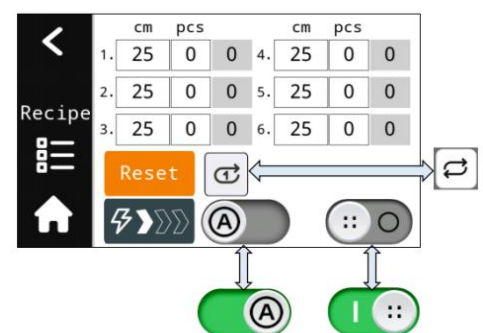

Figure 5

4) Output Mode:

: Once Mode. Produce one pad of paper when triggering.

: Constantly Mode. Produce paper automatically when previous pad is taken away, until the preset recipe has been completed.

: Circular Mode. Produce paper automatically when previous pad is taken away, until the machine is stopped manually or the paper runs out.

5) Reset Sequence: Tap when the machine is stopped. When restarting the machine it will produce from the first series of numbers.

7.9. Statistics

This interface enables users to view machine statistics such as total length, power-on time and pad amount.

1) Tap in the homepage to enter this page. (Figure 6).

2) After clearing the warnings, you can tap to reset all statistics when the machine has stopped.

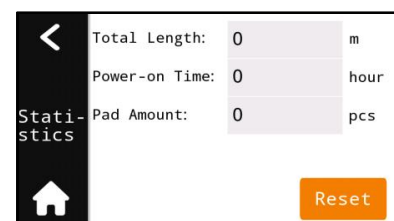

Figure 6

7.10. Settings

This interface enables users to enter pages of Clear, Diagnosis, Advanced, Language and About.

Tap in the homepage to enter this page. (Figure 7a).

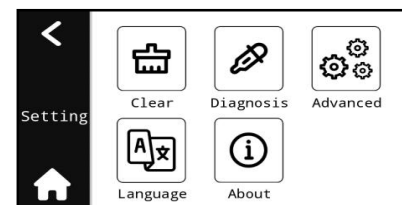

Figure 7a

7.10.1. Clear

This interface enables users to resolve paper jams.



Beware of hurting hands!

Keep away from cutters to avoid injury when operating the machine.

1) Tap in the settings page to enter this page. (Figure 7b).

2) Follow the steps shown on the screen.

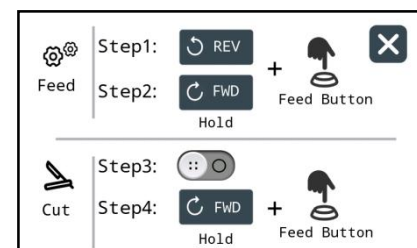

Figure 7b

7.10.2. Language

This interface enables users to switch languages ;



- 1) Tap  in the settings page to enter this page. (Figure 7c).
- 2) Tap  to change the unit system.
- 3) Tap on the national flag to change the language. The white circle under the flags will turn green on success.



Figure 7c

7.10.3. About

This interface enables users to scan the QR code for more information and videos.

- 1) Tap  in the settings page to enter this page.(Figure 7d).
- 2) Use the mobile to scan the QR code to get more information.
 - a. **Contact:** *Locked Paper* Official Website
 - b. **Support:** YouTube
 - c. **Info:** Machine Version
 - d. **Core:** Control Program Version
 - e. **HMI:** Screen Program Version



Figure 7d

7.10.4. Diagnosis

This interface enables users to diagnose the working status of the motor and sensor control parts.

7.10.5. Advanced

This interface enables users to temporarily resolve machine errors.

Contact to get after-sales service if you need it:

Email: info@lockedair.com

Call: +86 0571 86169196

8. Troubleshooting

The machine will pop out a warning indicating the reasons for the breakdown or unexpected shut down.

Please follow this steps to troubleshoot: **(If the information displayed is not listed below, please contact the *Locked Paper* distributor for processing).**

Warnings	Reasons	Solutions (unplug the power cable before operating)
E001: No paper at outlet.	1. Abnormal paper shape outlet. 2. Paper outlet channel damaged.	1. Check the paper to see if the shape is , if the length is too short, and if it is torn off at the datum line. 2. Check the channel whether it is deformed ;
E002: No paper at inlet.	Paper tear off at input channel	1. Check the paper input whether it is tearing off. 2. Check to see if the consumable is too soft, too thick, or if it tears off easily.
E003: No paper upon the tray.	Consumable runs out	Tap the Back button to clear errors, and replenish consumables ;
E004: Shell is open.	1. The front or back shell is open. 2. Safety lock or cable broken.	1. Close the front or back shell, then tap the Retry button to clear errors. 2. Check whether the shell is deformed

E010: Blade IS NOT at initial position.

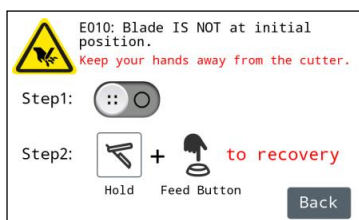

E013: Paper Jam at cut position.

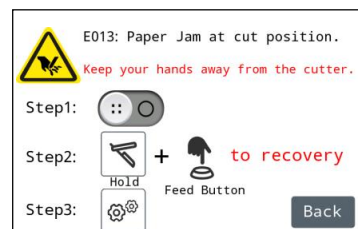

E012: Blade FAILED to return to initial position.

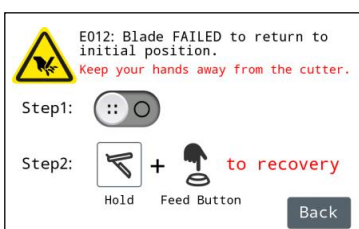

E021: Paper Jam at outlet

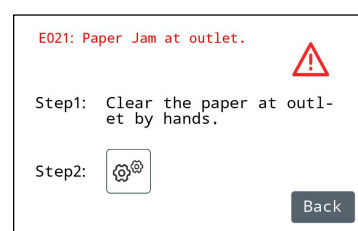

9. Maintenance

9.1. Preventive Maintenance

Warning! The machine must be switched off and the power supply must be disconnected during the maintenance work.

- Please be aware of the sharp corner, and take care not to hurt yourself.
- Please do not operate the machine with the safety device removed.

Maintenance Period	Items	Details
Monthly	Cleaning items	<ul style="list-style-type: none"> · Clean the machine and remove the scrapes of paper inside. · Wipe the machine with a dry or slightly damp cloth to remove any paper dust.
	Checking items	<ul style="list-style-type: none"> · Working status of the motion mechanism. · Whether the warning labels are clear and legible. · Wear and tear of parts. · Working status of the safety insurance parts. · Clean the area around the cutters. · The quality of the produced consumables.
Annually	Professional maintenance	Maintained by a certified service technician at least once a year.

9.2. Repair and Replace Parts

All maintenance work must be carried out by a certified service technician.

- Only the *Locked Paper Part* is permitted to replace machine parts.
- The *Locked Paper Part* can be ordered from the distributor.
- Please adhere to the instructions above to prevent any damage to the machine.

The manufacturer or distributor disclaim all responsibility if the instructions are not followed.

➤ **Customer service**

✧ **Notice to customers: :**

Locked paper™ Paper Cushion Machine is manufactured by Hangzhou Bingjia Technology Co., Ltd. and is fully tested before shipment. However, if a problem arises while the machine is operating, please contact our customer service department using any of the service phone numbers listed below.

Customer Service and Spare Parts Service:

1. Please call your Locked air customer representative
2. Please contact our customer service by email: info@lockedair.com

✧ **Technical Customer Service**

If any unusual problems occur with the device, please confirm the following information:

1. Customer details: Your company name, contact number
2. Serial number of machine "BJTLP-C1_____"
3. Describe the problems encountered in detail.